

Features

- Cavity Band Pass Filter (9,125 MHz ~ 9,175 MHz)
- Very compact size and low weight
- Typical 0.8 dB Insertion Loss



Specifications

Parameter	Specifications	Remarks
Frequency Range	9,125 ~ 9,175 MHz	BW : 50 MHz
Center Frequency	9,150 MHz	
Insertion Loss (Max.)	1.0 dB	
Pass Band Ripple (Max.)	0.5 dB	
Return Loss (Min.)	15.0 dB	
Rejection (Min.)	48 dBc @ 8,400 MHz	
In/ Out Impedance	50 Ω	
Handling Power (Max.)	CW 10 W	
Operating Temperature	-40 °C ~ +85 °C	
Dimensions	33.4 * 12.7 * 14 mm	Excluding Connectors
Connector	SMA (Female)	

Outline drawing

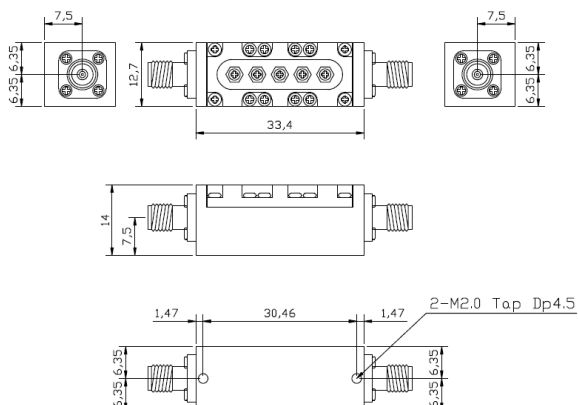

Typical Response

